



SSC-JE

STAFF SELECTION COMMISSION

CIVIL ENGINEERING

STUDY MATERIAL

ESTIMATING, COSTING AND VALUATION

Estimating, Costing and Valuation : Estimate, Glossary of technical terms, Analysis of rates, Methods and unit of measurement, Items of work – Earthwork, Brick work (Modular & Traditional bricks), RCC work, Shuttering, Timber work, Painting, Flooring, Plastering. Boundary wall, Brick building, Water Tank, Septic tank, Bar bending schedule. Centre line method, Mid-section formula, Trapezoidal formula, Simpson’s rule. Cost estimate of Septic tank, flexible pavements, Tube well, isolated and combined footings, Steel Truss, Piles and pile-caps. Valuation – Value and cost, scrap value, salvage value, assessed value, sinking fund, depreciation and obsolescence, methods of valuation.

CONTENT

1. CPM AND PERT	03-23
2. CRASHING OF NETWORK	24-31
3. ENGINEERING ECONOMY	32-46
4. BUILDING ESTIMATION.....	47-51
5. ANALYSIS OF RATES	52-66
6. EARTHWORK	67-72
7. VALUATION	73-76

CHAPTER-1

CPM & PERT

PROJECT:

- A project is made up of a group of interrelated work activities constrained by a specific scope, budget and schedule to achieve the specific goals of an agency.
- Projects are defined by their scope, budget and schedule.

Project cost:

- Project cost comprises of material cost and equipment cost.
- To reduce project cost, both material and construction cost are to be reduced.
- Material cost can be reduced by adopting different design philosophies.
- Construction cost is reduced with help of numerical techniques such as CPM and PERT

Note: A project has a specific purpose. It starts at a specific point and is finished when its object is achieved/fulfilled.

Project Management:

Objective:

- To complete the project with minimum elapsed time.
- To minimize the project cost while satisfactorily completing the task.
- Optimum use of available resources.

Resources

Resources are of two types

- (i) **Physical Resources:** e.g., Manpower, Equipment, Space, Materials etc.
- (ii) **Non-Physical Resources:** e.g., Time.

Various Phases of a Project :

1. Planning:

- Efficient use of machineries, material, men etc. along with minimizing resource cost is the basic aim of this phase.
- It involves proper sequencing of events.

2. Scheduling :

- Scheduling is basically the allocation of resources.
- Process of sequencing various events of a project within a timeframe.
- Required for continuous tracking of project, resource mobilization etc.
- Useful in minimizing the cost and optimal use of resources.
- Assigning dates for start and completion of each activity in logical sequence in systematic manner.

3. Controlling & Monitoring :

- Execution of the project is monitored for its timely completion.
- In controlling, actual activities that are to be performed are monitored and if there is any deviation from the original plan, it is rescheduled and re-planned in such a way that project is completed in time.
- To monitor project cost, progress of construction, etc.

Note: The first method that was developed for planning a project is called project planning & scheduling (PPS). Critical path method (CPM) came later and are generally used these days for similar type of project and it has a deterministic approach.

TECHNIQUE USED FOR PROJECT MANAGEMENT:

(I) **Bar chart :** [Characteristic] [Developed by Gantt in 1900 AD]

- (i) It is simple & easy to understand.
- (ii) It is graphical arrangement of the activities on the time scale.
- (iii) A bar chart consist of two co – ordinate axes one representing the time elapsed and other represent the jobs or activities to be performed.
- (iv) It is a pictorial representation.
- (v) The activities are represented in the form of bars, whereas the beginning and the end point of the bar represents the starting and finish time of the activity. Hence the length of the bar signifies the duration of a particular activity.
- (vi) Shaded width of bar represents the percentage completion of that particular activity.
- (vii) It is used only for small scale project.

Short comings of bar chart:

- (i) Can be used for small projects only
- (ii) Can be used for the projects which are repetitive in nature.
- (iii) Lack of details:
Only major actives are shown in a bar chart and sub activities cannot be separated out. It too many activities or tasks are shown separately it becomes clumsy.
- (iv) Review of project progress:
It cannot be used as a control device as it does not shows the progress of work
- (v) Activity inter relationship:
In a project there can be several activities which may start concurrently, bar char cannot differentiate such activities.
- (vi) Time uncertainties:
Bar charts are not useful in the project where there are uncertainties in determination of estimation of time required for completion of various activities.
- (vii) Bar chart cannot differentiate between critical and non – critical activities. Hence updating of individual activities of resources smoothing and resource leveling cannot be done.

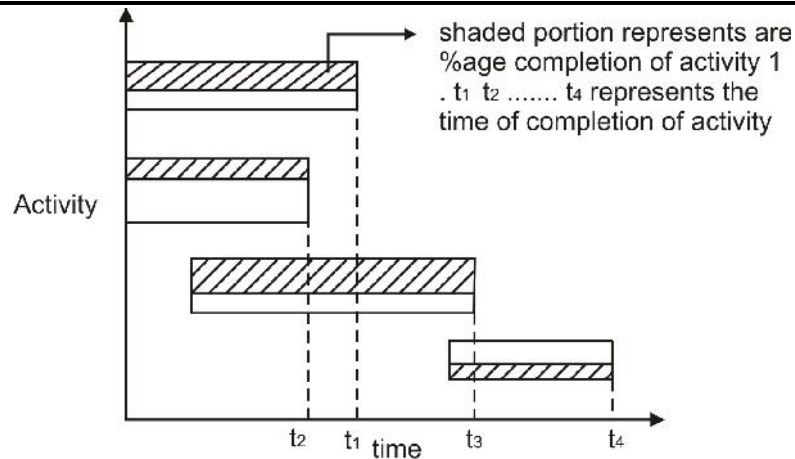

(II) Milestone chart:

- i) It is an improvement over the original Gantt chart. Milestones are specific points in time which mark the completion of certain portions of the main activity.
- ii) It gives idea about completion of sub activities.
- iii) Controlling can be better achieved but still activity inters relationship and accountability of time uncertainly cannot be depicted.
This can be achieved by network method discussed further.

Network Methods

- CPM & PERT are two major network methods.
- Other network methods are like UNETICS, LESS, TOPS and SCANS. However PERT & CPM are major network method.

CPM : Critical Path Method

- It involves deterministic approach.
- Used for repetitive project, e.g. construction of a building.

PERT : Project / Programme Evaluation and Review Technique.

- It involves probabilistic approach.
- Used for research and development projects, e.g. Missile Programme.

Network Diagram

- It is a flow diagram consisting of activities and events connected logically and sequentially.
- In network diagram, all the limitations of bar chart and milestone chart are removed and they are generally used for big and complex projects.

Elements of a Network

1. Activity :

- It represents execution of a specific job.
 - It requires time and resources. For its completion.
 - It is represented by an arrow.
- e.g. - Brickwork, Plastering etc.

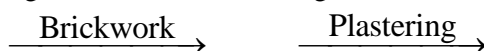

- Activities which can be performed simultaneously and are independent of each other are called parallel activity.
- The activities which are performed one after the another are known as serial activities. These activities are dependent upon each other.
- Activities performed prior to an activity under consideration are called as predecessor activities to that activity.

- Activities performed after completion of an activity under consideration are called as successor activities to that activity.

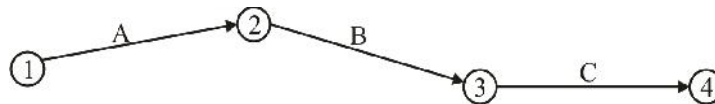

“A” is predecessor activity of “B”.

“C” is successor activity of “B”.

AoA system (Activity on arrow system) is represented by arrow between events.

AoN system (Activity on Node) system is represented by activity on nodes. Events have no place in such system.

2. Event :

- It represents start or end of a task.
- It is generally represented by a circle.

Note: Circle is generally used but event can be represented by any shape.

- Beginning of an activity is called **tail event** and denoted by “i-node”.

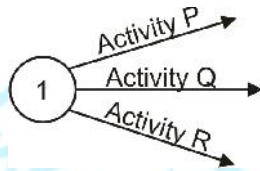

- Completion of an activity is called **head event** and denoted by “j-node”. Add (8)

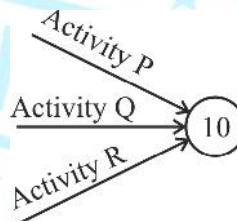

- Events which occurred prior to an event under consideration are called as **predecessor event** to that event.
- Events which occur after an event under consideration are called as **successor event** to that event.

Events are represented by nodes in a network. It may have the following shapes.

- Circular
- Rectangular
- Square
- Oval

- If a tail event marks the beginning of a project then it is known as initial event.
- If a head event marks the ending of a project, it is known as finish event.
- The events which acts as both head and tail events are known as dual role events.
- There can only be one initial event and one finish event in a project.

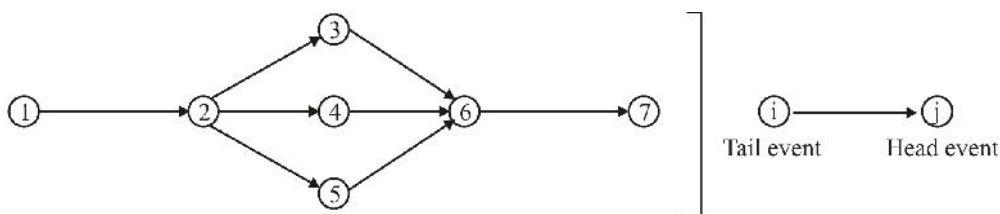

(1) Is initial event

(7) Is finish event

- (1), (2) are predecessors event to (3).
 (6), (7) are successor events to (3).
 Event (2), (3), (4), (5) & (6) are dual role events.

3. Dummy:

- It denotes an artificial activity.
- It is represented by a dotted arrow.
- It indicates that an activity following the dummy cannot be started until the activities preceding the dummy are not completed.
- It does not require time or resources.
- It denotes depending among the activities

Objective:

- (a) To avoid geometrical/grammatical mistakes.
 (b) To establish logical relationship between activities.

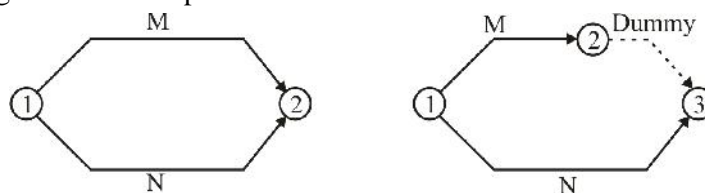

Type (a)

Use of "Dummy" here gives both activities a unique identification.

$$M \rightarrow ①-②$$

$$N \rightarrow ①-②$$

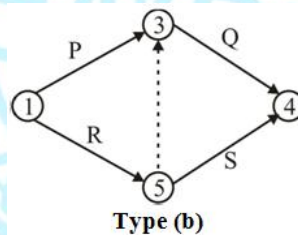

Type (b)

- Dummies are used to show predecessor relationship but if that relation is perfectly established inside the network, then such dummy is a redundant & should be removed.
- If dummy is only incoming arrow to a node then it can be removed provided there is no logical or grammatical error.

Rule of Network:

- In every project network, there should be only one initial and final event.
- Events occur in a particular order and any event cannot occur until all the predecessor events are not completed.
- Time flow is preferably assumed from left to right.
- Normally, arrows should not cross each other. If it is necessary to cross each other, the arrow should make a bridge over the other.

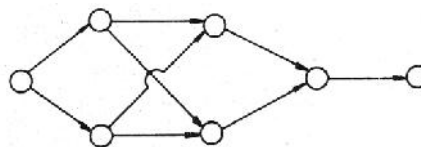

- Every activity should have its own "i-j" node, such that value of "j-node" should always be greater than "i-node".
- Number of arrows should be equal to the number of activities.

- An event cannot occur twice.

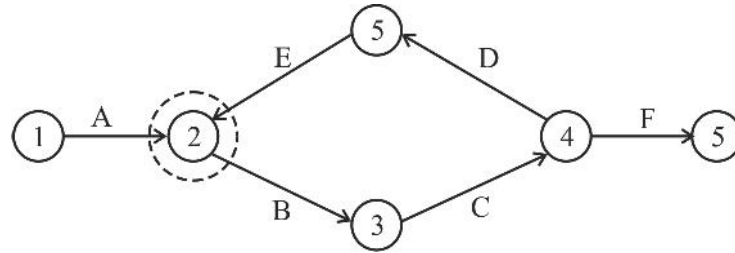

i.e., Error occurs at event (2) due to looping

Note: An arrow used to represent the activity in the network is not a vector.

Fulkerson’s rule for numbering the node of events:

- 1. The initial event is numbered as (1, 10 etc.)
- 2. Now all arrows coming out of initial event (1, 10 etc.) are removed. Thus one or more initial events are created which is numbered as (2,3,4 etc.....or 20,30,40 etc...)
- 3. Step 2 is repeated until the final event of the network is not numbered.

Note: During the controlling phase, new events may be added in the network or existing events may be removed from the network requiring the re-numbering of the network.

In such cases, skip numbering of events is done to avoid the renumbering in network.

Errors in Network:

1. Looping Error:

- It generates logical problem in the network.

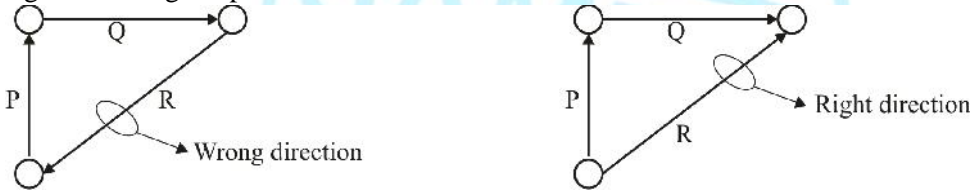

2. Dangling Error:

- Each network should contain only one initial event and one final event.

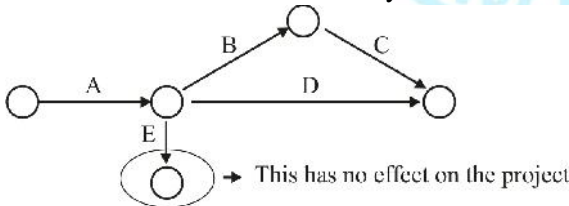

3. Wagon Wheel Error:

- It generates logical error in network.

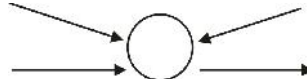

CPM NETWORK:

- In CPM, only one time estimate is done for each activity since it is based upon deterministic approach.

Critical Path:

- It is defined as the path of longest project duration.
- The activities lying in critical path are called critical activities.
- Hence critical activities signify that any delay in critical activities will ultimately delay the overall project.
- All other activities which are not on critical path will not affect total duration of project.
- Alternatively, it can be stated that critical path is the shortest possible duration to complete the job/project.

Computation of project time:

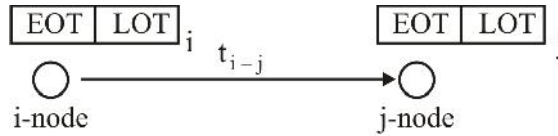
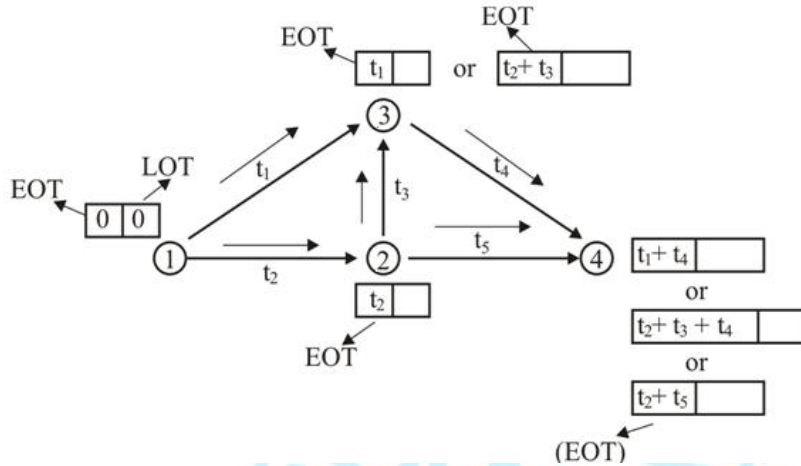

Figure (a)

- The box at the “i-node” contains two terms:
 - (i) EOT- Earliest occurrence time at i-node.
 - (ii) LOT- Latest occurrence time at i-node.
- " t_{i-j} " → Duration of Activity.

EOT& LOT:



- It is the earliest time when an event can occur.
- In general ,it can be written as:

$$(EOT)_j = (EOT)_i + t_{i-j} \dots\dots(i)$$

- To compute the (EOT)at all the nodes:

- i. Assume the value of

EOT	LOT
-----	-----

 at first node i.e. at 1 equal to

0	0
---	---
- ii. Now, calculate the value at the other nodes using above equation
 $\therefore (EOT)_2 = 0 + t_2 = t_2$ (at node only one activity merges)

$$\left. \begin{aligned} (EOT)_2 &= 0 + t_1 = t_1 \\ \text{OR} \\ &= t_2 + t_3 = (t_2 + t_3) \end{aligned} \right\} \therefore (EOT)_3 = \text{Maximum of } (t_1, (t_2 + t_3))$$

- Then, proceed with maximum value of (EOT)₂
 (for illustration both values is taken here for calculation at (EOT)₄)

$$(EOT)_4 = \text{Maximum of } \begin{cases} (t_1) + (t_4) = t_1 + t_4 \\ (t_2 + t_3) + (t_4) = t_2 + t_3 + t_4 \\ (t_2) + (t_5) = t_2 + t_5 \end{cases}$$

- Hence, in general it can be stated that

$$(EOT)_j = \left[(EOT)_i + t_{i-j} \right]_{\max.}$$

if more than one activities merge at an event.

- Total project time is given by (EOT)₄ or EOT of last event.
- Thus, it is calculated by forward method.

e.g.

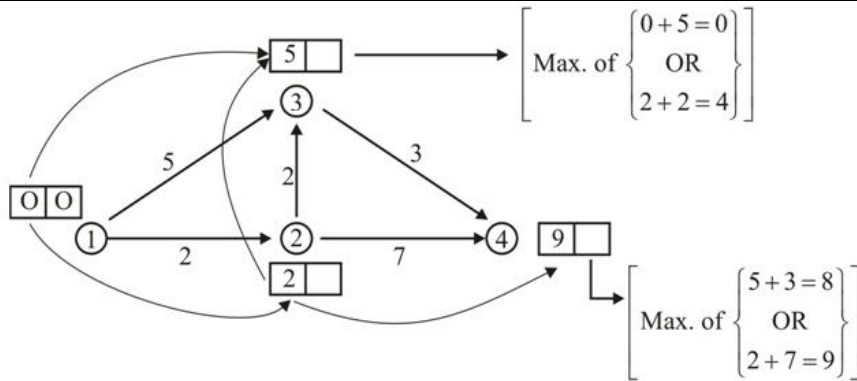

➤ Proceed with previous figure

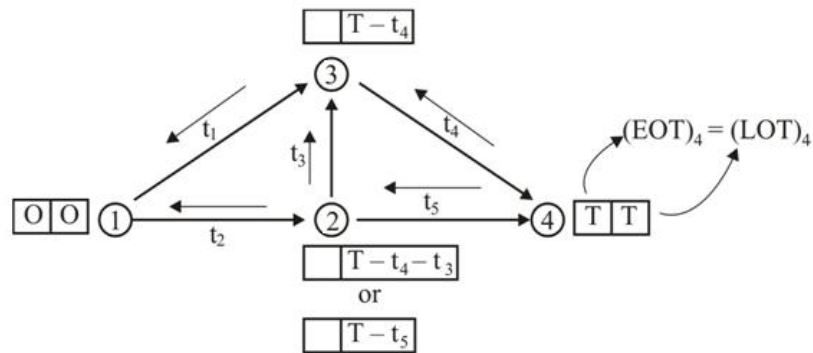

- It is defined as the latest possible time at which event may take place without affecting the total project duration which is calculated by forward pass method.
- Hence, (LOT) of last event is taken equal to (EOT) of last event.

Hence, $(EOT)_4 = (LOT)_4 = T$

➤ In general, $(LOT)_i = (LOT)_j - t_{i-j}$ (ii)

➤ It is also known as backward pass method.

➤ Now calculate values at other nodes using above equation (ii)

$(LOT)_3 = T - t_4$ [only one activity meets at this event while tracing in backward direction]

$$(LOT)_2 = \text{Minimum of } \begin{cases} T - t_5 = T - t_5 \\ (T - t_4) - t_3 = T - t_4 - t_3 \end{cases}$$

Similarly, $(LOT)_1 = \text{Minimum of values calculated at 1}$

[since, it is initial event, hence it should be equal to $(EOT)_1 = 0$]

➤ Hence ,it can be stated as :

$$(LOT)_i = [(LOT)_j - t_{i-j}]_{\min.} - \text{Minimum of all the values,if more than one activity merges at an event.}$$

e.g. using the previous example:

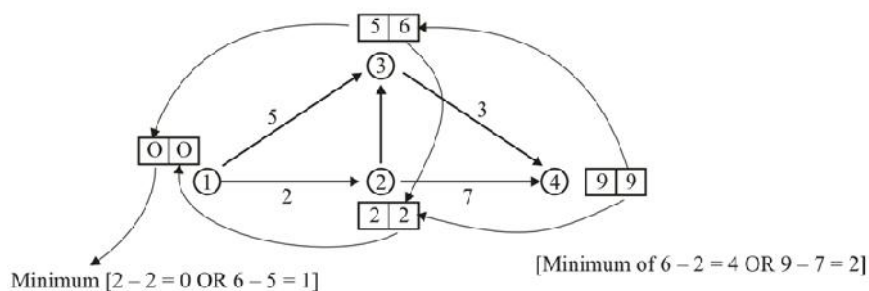

Notes:

- I. Nodes having some values of EOT and LOT are called as critical nodes. And the paths connecting the critical nodes are called as critical path.
- II. A project may have more than one critical paths, but the time taken by each critical paths will be same.

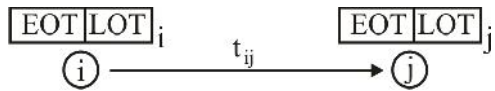
Activity time in CPM:**1. EST: Earliest Start Time:**

- It is the earliest possible time at which an activity may start.

$$(EST)_{i-j} = (EOT)_i$$

2. EFT.: Earliest Finish Time:

- It is the earliest possible time at which an activity may finish

$$(EFT)_{i-j} = (EOT)_i + t_{ij}$$

3. LST : Latest Start Time:

- It is the latest possible time at which an activity may start without any delay in project duration.

$$(LST)_{i-j} = (LOT)_j - t_{ij}$$

4. LFT. : Latest Finish Time:

- It is the latest possible time at which an activity may finish without any delay in project duration.

$$(LFT)_{i-j} = (LOT)_j$$

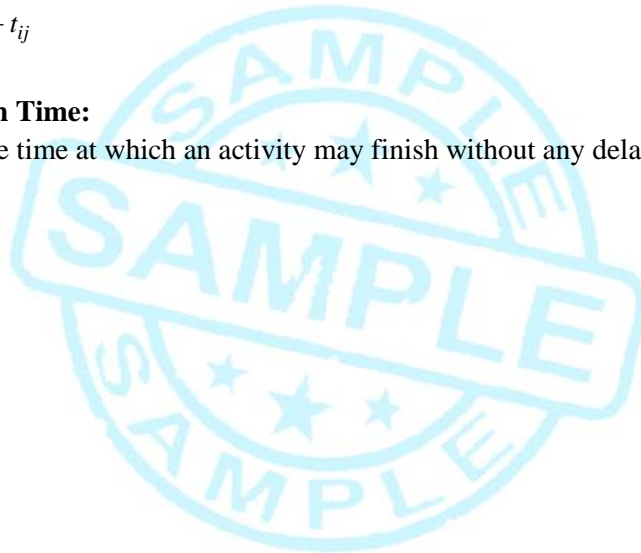

Float:

- The range within which the start time or finish time of any activity may vary such that it doesn't affect the scheduled completion of project.
- It is of four types:
- 1. Total Float (ft.):**
- It is given by the difference of maximum available time of an activity and the activity duration.
- It is the time by which starting or finishing of an activity can be delayed without affecting the completion time of project.
- In calculation, it is assumed that the preceder activity is finished at its earliest time and its successor activity starts at its latest time.

$$\therefore F_t = ((LOT)_j - (EOT)_i) - t_{ij}$$

- It affects the total float of succeeding and preceding activities.

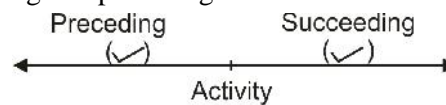
**2. Free Float (F_f) :**

- It is given by the difference of available time when all events start as early as possible and the activity duration.
- It is that positive portion of total float which can be used by an activity without causing any delay in the succeeding activity.

$$F_f = ((EOT)_j - (EOT)_i) - t_{ij}$$

Free float = Total float – head event slack

- It does not affect the succeeding activities.

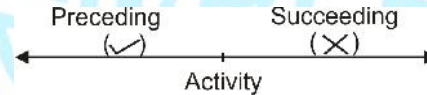
**3. Independent Float (F_{ind.}):**

- It is given by the difference of minimum available time .i.e. activity starts as latest as possible $[(LOT)_i]$ and finishes as early as possible $(EOT)_j$ and the activity duration.

$$F_{ind.} = ((EOT)_j - (LOT)_i) - t_{ij}$$

Independent float = Free float – tail event slack

- In some cases, it does not affect succeeding activity or preceding activity.
- If the value of it comes to be negative, it is taken as zero.

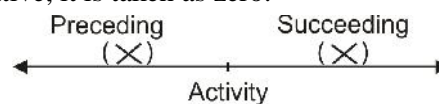
**4. Interfering Float (F_{int.}):**

- It is the difference of total float and free float.

$$F_{int.} = F_t - F_f$$

Interfering float = head event slack

- It is equal to head event slack.

Notes:

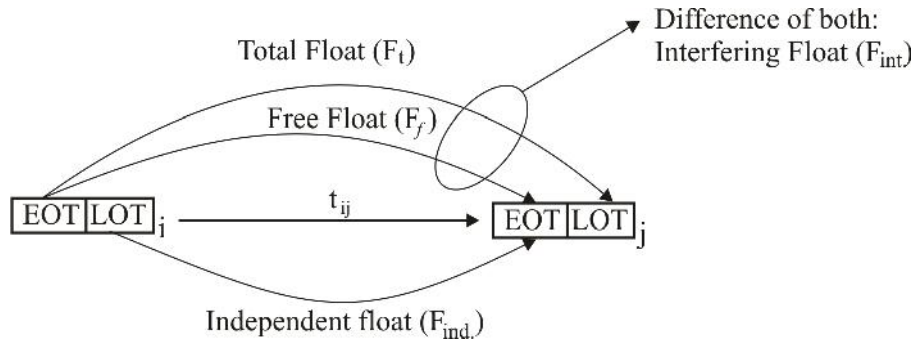

- Here, floats indicated on arrow can be obtained by difference of value at head and tail of arrow and activity duration (t_{ij})
- All the four floats of each activity on critical path are zero.
- The activity for which total float is negative is known as super critical activity and the path joining the super critical activity is known as super critical path.

The activities can be classified on the basis of degree of the float

- a. Super- critical activity: the float of such activity is negative. They demand very special attention.
- b. Critical activity: the float of these activities is zero
- c. Sub-critical activity : The float of such activities is positive. They need normal attention.

Slack (s):

- It denotes the range within which an event can occur.

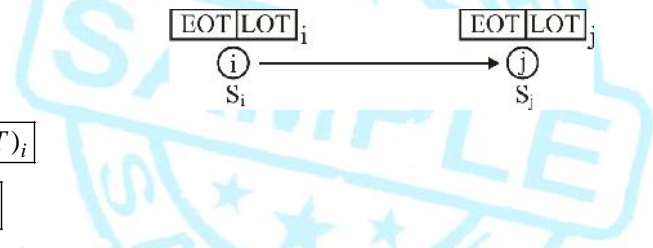

➤ i.e. $s_i = (LOT - EOT)_i$

$s_j = (LOT - EOT)_j$

- The minimum value of slack is zero i.e.it indicates about critical event.

CPM Network

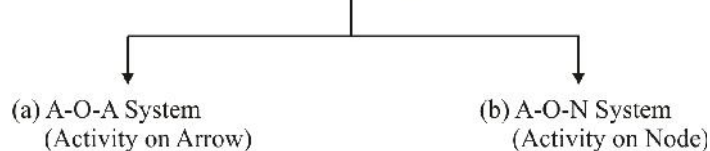

(a) A-O-A System

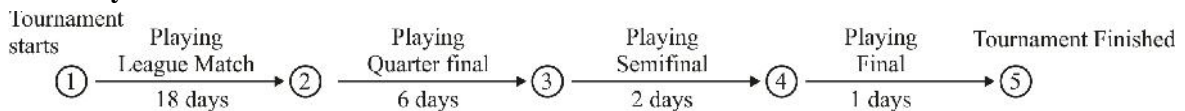

- In this system generally activity is written on one side of arrow and activity duration on other side of arrow.
- Dummies are also used as per network requirement. Also number of dummies should be kept minimum.
- Nodes represent events.

(b) A-O-N System :

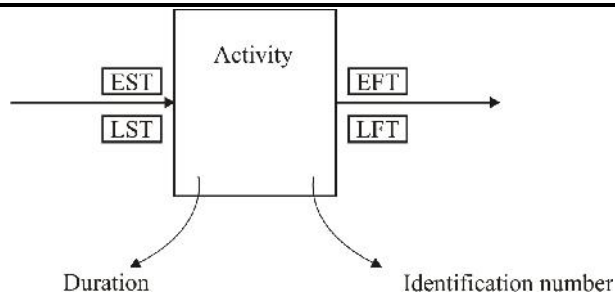

- In this network, activities are represented on a node as shown above and arrows are used to establish the inter-relationship between the different activities of the network.
- These nodes can be re-presented by any shape, though rectangular shape is most common.
- Also known as precedence diagram.
- There is no place for events and entire network constitute of activities only.
- Suitable for CPM analysis.
- It eliminates use of dummies.

PERT NETWORK :

- PERT: Project/Programme Evaluation and Review Technique.
- It is used in the cases of Research and Development Projects, projects which involve uncertainty in time estimation.
- PERT is event oriented programming technique in which time cannot be estimated accurately.
- It is based on probabilistic approach.
- It involves three types of time estimates:

(a) Optimistic Time (T_o):

- It is the minimum time required for an activity assuming ideal conditions during execution.

(b) Pessimistic Time (T_p):

- It is the maximum time required for an activity if unfavorable conditions exist during execution.

(c) Most Likely Time (T_m):

- It signifies most frequent occurrence time of an activity.
- It is generally estimated based on past experience of executing the same activity many a times.

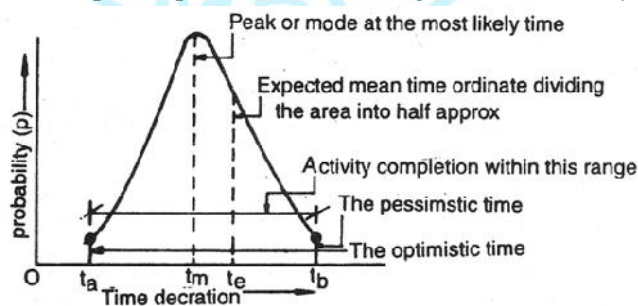

Figure: Probability distribution curve for activity duration

- It represents a situation in which things are as usual and none of the activities is non-scheduled.
- In PERT network analysis, “S (beta)-distribution” curve is used, because this curve yields good result for most of the activities.

Frequency Distribution:

It is the graphical representation of any parameter with respect to number of times that parameter has occurred in the given set of observation.

Probability Distribution

- Probability distribution curve is the frequency distribution curve whose height is standardized in such a manner that the area under this curve is unity.
- If probability distribution curve is symmetric, it is known as normal probability distribution curve and if it is not symmetric, it is known as β -distribution curve.

1. Expected mean time of an activity(T_e):

- It is the average time in which the activity may be computed, with the probability of 50%
- It is calculated by giving the weight age factor of '1' to both optimistic and pessimistic time and weight age factor of '4' to most likely time.

$$T_e = \frac{T_o + 4T_m + T_p}{6}$$

2. Standard Deviation of an activity(\dagger):

$$\dagger = \frac{T_p - T_o}{6}$$

3. Variance of an activity($\hat{\ }^2$):

$$\hat{\ }^2 = \dagger^2 = \left(\frac{T_p - T_o}{6} \right)^2 \text{ or, } \dagger = \sqrt{\hat{\ }^2}$$

Critical Path:

- The definition of critical path in PERT Network is same as that for CPM Network.
- For calculation purpose all the three time, T_o , T_p & T_m are converted into expected time (T_e) [it will be used in place of activity time t_{i-j}]
- Hence,

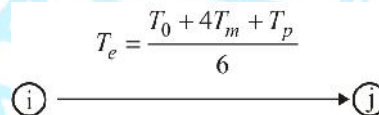
$$T_e = \frac{T_o + 4T_m + T_p}{6}$$

Note: When all the time co-ordinates i.e. T_p , T_m & T_o coincides such that variance is 0 then the duration of the activity becomes certain and deterministic i.e. it changes into CPM. Hence it can be concluded that PERT is a general case where as CPM is the particular case of PERT.

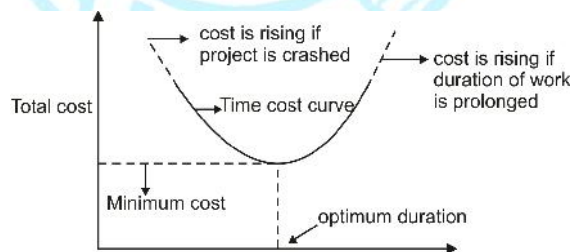
**Earliest expected occurrence time (T_E):**

- It is same as that of earliest occurrence time (EOT) of CPM. Hence it is given as :

$$(T_E)_j = \left[(T_E)_i + t_{i-j} \right]_{\max.} \text{ When more than one activity merges at an event.}$$

Latest Allowable occurrence time (T_L):

- It is same as that of latest occurrence time (LOT) of CPM.
- Hence it is given as:

$$(T_L)_i = \left[(T_L)_j - t_{i-j} \right]_{\min.} \text{ When more than one activity merges at an event.}$$

- Scheduled completion time (T_s) of project is taken equal to " T_L " of the last event.

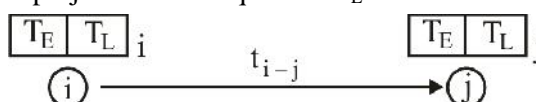

SLACK(s):

➤ It denotes the range within which an event can occur, same as that of CPM Network:

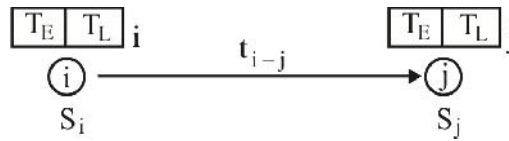

➤ i.e. $S_i = (T_L - T_E)_i$ & $S_j = (T_L - T_E)_j$

➤ Unlike the value of slack in CPM Network, in PERT network, the value of slack may be positive, zero, negative.

1. Positive Slack (s) > 0; i.e. Project is ahead of schedule, hence excess resources are available.
2. Zero Slack (s) = 0; i.e. Project is running as per schedule, hence resources are adequately available.
3. Negative Slack (s) < 0; i.e. Project is behind schedule; hence resources are not adequately available.

Notes:

Events which have least value of slack are treated as critical event. And the path joining critical events is called critical path.

Central Mean Theorem for PERT Network:

➤ **As per this theorem:**

If there are “r” activities along a critical path and each activity is having its own S -distribution curve such that their expected mean time are $\sim_1, \sim_2, \sim_3, \dots, \sim_r$

Standard deviation are $\dagger_1, \dagger_2, \dagger_3, \dots, \dagger_r$.

& Variance are $\hat{1}, \hat{2}, \hat{3}, \dots, \hat{r}$

Then distribution of project time will be approximately a **Normal distribution curve such that**

Expected mean time of project, $\sim_T = \sim_1 + \sim_2 + \dots + \sim_r = \sum_{i=1}^r \sim_i$

Standard deviance of project, $\dagger_T = \sqrt{\hat{T}}$ or $\dagger_T = \sqrt{\dagger_1^2 + \dagger_2^2 + \dots + \dagger_r^2}$

& variance of project, $\hat{T} = \hat{1} + \hat{2} + \dots + \hat{r} = \sum_{i=1}^r \hat{i}$

➤ The range of project is from $(\sim_T - 3\dagger_T)$ to $(\sim_T + 3\dagger_T)$.

➤ **If more than one critical path exists, the path having maximum variance is taken for calculation purpose.**

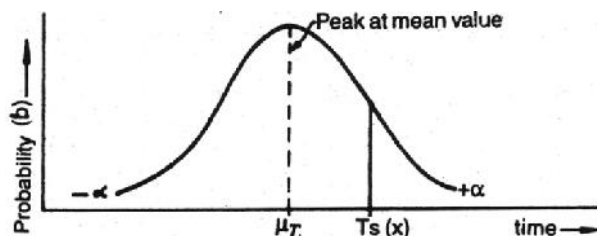

Figure: Normal Distribution Curve

➤ Probability of meeting the scheduled completion time (T_s) is given as :

$p = \frac{1}{\sqrt{2f}} \int_0^z e^{-\frac{z^2}{2}} dz$ Where Z = probability factor = $\frac{x - \sim_T}{\dagger_T}$

➤ If $z > 0$; chances of meeting the scheduled completion time is more than 50%.

$Z = 0$; chances of meeting the scheduled completion time is 50%.

$Z < 0$; chances of meeting the scheduled completion time is less than 50%

Table		Normal Distribution Function	
Normal Deviate (Probability factor) $Z+$	Probability (%)	Normal Deviate (Probability factor)	Probability (%)
0	50.00	0	50.00
+0.1	53.98	-0.1	46.02
+0.2	57.93	-2.0	42.07
+0.3	61.79	-0.3	38.21
+0.4	65.54	-0.4	34.46
+0.5	69.15	-0.5	30.85
+0.6	72.57	-0.6	27.43
+0.7	75.80	-0.7	24.20
+0.8	78.81	-0.8	21.19
+0.9	81.59	-0.9	18.41
+1.0	84.13	-1.0	15.87
+1.1	86.43	-1.1	13.57
+1.2	88.49	-1.2	11.51
+1.3	90.32	-1.3	9.68
+1.4	91.92	-1.4	8.08
+1.5	93.32	-1.5	6.68
+1.6	94.52	-1.6	5.48
+1.7	95.54	-1.7	4.46
+1.8	96.54	-1.8	3.59
+1.9	97.13	-1.9	2.87
+2.0	97.72	-2.0	2.28
+2.1	98.21	-2.1	1.79
+2.2	98.61	-2.2	1.39
+2.3	98.93	-2.3	1.07
+2.4	99.18	-2.4	0.82
+2.5	99.38	-2.5	0.62
+2.6	99.53	-2.6	0.47
+2.7	99.65	-2.7	0.35
+2.8	99.74	-2.8	0.26
+2.9	99.81	-2.9	0.19
+3.0	99.87	-3.0	0.13

➤ **Difference between CPM & PERT :****Table**

CPM	PERT
<ol style="list-style-type: none"> 1. It is having DETERMINISTIC approach in the design of network. 2. Only one time estimate is required for each activity 3. It is built-up of activity-oriented diagram. 4. Time and cost both are controlling factors. There is an optimum duration of the project at which the project cost is minimum and this can be obtained by crashing the net work. 5. Critical events must have zero slack. 6. It is recommended for repetitive nature of work where past experiences are adequately available. 	<ol style="list-style-type: none"> 1. It is having PROBABILISTIC approach in the design of network. 2. Three Time Estimate (in the form of Pessimistic time, Optimistic time and Most likely time) for each activity 3. It is built-up of event-oriented diagram. 4. Time only is the controlling factor and the cost is assumed proportional to the project duration. 5. Critical events may be positive/zero/negative depending upon the project scheduled completion time. 6. It is recommended for research and development project where no past experiences are available or where great uncertainty lies in the time estimation.

Note: A project comprises of several activities and in PERT, each activity is assumed to follow β - distribution but project as a whole is assumed to follow normal probability distribution.

Key Points

1. CPM and PERT are two major network methods.
2. CPM involves deterministic approach and is used for repetitive projects.
3. PERT involves probabilistic approach and is used for research and development projects.
4. Events can be represented by any shape.
5. Dummy activity is an artificial activity of zero duration.
6. Fulkerson's rule is used for node numbering.
7. In PERT, expected time
$$T_e = \frac{T_o + 4T_m + T_p}{\sigma}$$
8.
$$\sigma = \frac{T_p - T_o}{\sigma}$$
9. Activities on critical path have zero slack or float.

Practice Set – I

- Which one of the following represents an activity
 (a) curing of concrete (b) excavation for foundation
 (c) preparing estimate (d) all of the above
- If t_o , t_p and t_m are the optimistic, pessimistic and most likely time estimates of an activity respectively, the expected time t of the activity will be
 (a) $(t_o+3t_m+t_p)/3$ (b) $(t_o+3t_m+t_p)/2$ (c) $(t_o+3t_m+t_p)/6$ (d) $(t_o+4t_m+t_p)/6$
- In the given figure, the network of a project represents

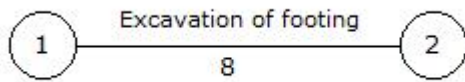

- activity of an excavation of a footing
 - activity of an excavation which starts at event No. 1 and ends at even No. 2
 - activity of excavation which takes 8 units of time
 - none of these.
- Various activities of a project, are shown on bar charts by
 (a) vertical lines (b) horizontal lines (c) dots (d) crosses
 - The time by which activity completion time can be delayed without affecting the start of succeeding activities, is known as
 (a) Duration (b) Total float (c) free float (d) interfering float
 - The difference between the time avail-to do a job and the time required to do the job, is known as
 (a) Event (b) Float (c) Duration (d) Constraint
 - Critical path lies along the activities having total float
 (a) Positive (b) Negative (c) Zero (d) Same
 - In PERT analysis, the time estimate of activity and probability of their occurrence follow
 (a) Normal distribution curve (b) Poisson's distribution curve
 (c) Beta- distribution curve (d) None of these
 - If an activity has its optimistic, most likely and pessimistic time as 2,3, and 7, then its expected time and variance are
 (a) 3.5 and 5/6 (b) 5 and 25/36 (c) 3.5 and 25/36 (d) 4 and 5/6
 - The independent float affects only
 (a) Preceding activity (b) Succeeding activity
 (c) The particular activity involved (d) None of the above
 - The time by which a particular activity can be delayed without affecting the preceding and succeeding activity is known as
 (a) Total float (b) Free float
 (c) Interfering float (d) Independent float
 - Bar charts are suitable for

- (a) Minor work
(c) Large project
- (b) Major work
(d) All of the above
13. If the total float and duration of an activity are 5 and 10 days respectively, the particular activity can be
(a) Started 5 days later
(b) Completed 5 days later
(c) Performed at slower rate in 15 days
(d) All the above
14. The probability of completion of any activity within its expected time is
(a) 50 %
(b) 84.1 %
(c) 99.9 %
(d) 100 %
15. In CPM analysis,
(a) Emphasis is given to activities
(b) Uncertainties are not allowed
(c) Activities are represented by arrows
(d) All the above
16. PERT technique of network analysis is mainly useful for
(a) Small projects
(b) Large and complex projects
(c) Research and development projects
(d) Deterministic activities
17. Which of the following statements is not correct
(a) PERT is probabilistic in nature.
(b) CPM is probabilistic in nature.
(c) CPM and PERT use similar terminology but were developed independently
(d) All of these statements are correct

Answer key

1	2	3	4	5	6	7	8	9	10
d	d	c	b	c	b	c	c	c	C
11	12	13	14	15	16	17	18	19	20
d	a	d	a	d	c	b			

To buy Complete Course Materials

Contact: 9990657855, 9278800100

Email : eiidelhi@gmail.com

Website : www.sscje.com

Classroom Coaching Program

Postal Coaching Program

Online Test Series