



# SSC-JE

STAFF SELECTION COMMISSION

ELECTRICAL ENGINEERING

**STUDY MATERIAL**

ELECTRICAL MACHINES

## CONTENT

1. ELECTRICAL MACHINES:  
DC MACHINE,  
TRANSFORMER AND INDUCTION MACHINE  
SPECIAL MACHINES  
STEPPER MOTOR ..... 3-131
  
2. SINGLE PHASE INDUCTION MOTOR ..... 132-146
  
3. SYNCHRONOUS MACHINES ..... 147-178



## CHAPTER-1

### DC MACHINES

#### A. PRINCIPLE OF ELECTROMECHANICAL ENERGY CONVERSION:

- The meaning of the words electromechanical energy conversion is conversion of electrical energy into mechanical energy or mechanical energy to electrical energy.
- The conversion of electrical energy to mechanical energy is achieved by using some type of a motor. An electric energy is applied to a motor. The motor rotates and converts electrical energy to mechanical energy at the shaft as shown in Figur-1(a).

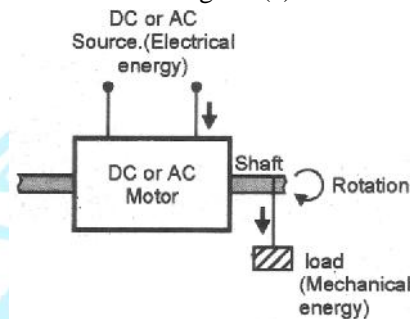

**Figure-1(a) : Electrical to mechanical energy conversion**

- Depending on the type of source of electrical energy, the motor can be an AC motor or a DC motor.
- Various types of motors available are listed in Figure-1(b).

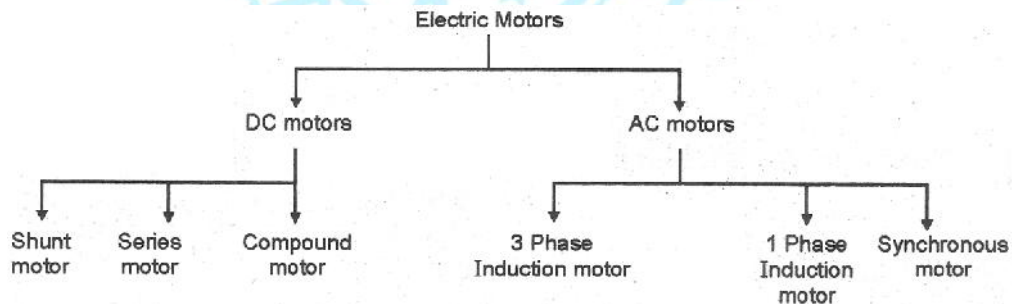

**Figure-1(b) : Types of motors**

- The motors continuously convert the electrical energy into mechanical energy. But some other devices are used to produce translational forces. The examples of such devices are solenoids, relays, electromagnets etc.
- An electric generator converts the mechanical energy applied at its input to an electrical energy as shown in Figure-1(c).
- A prime mover machine is required to be used to rotate the generator mechanically.

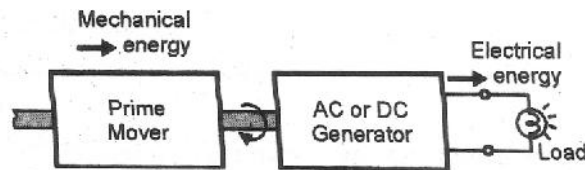

**Figure-1(c) : Mechanical to Electrical energy conversion**

- The generators can be AC generators or DC generators. The AC generators are called as alternators.
- The block diagram of a general electromechanical conversion system is shown in Figure-2.

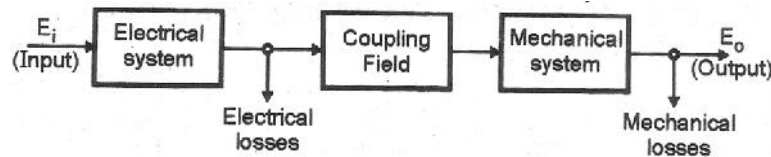

**Figure-2 : Electromechanical Energy Conversion**

- The three parts of electromechanical energy conversion devices are:
  1. Electrical system
  2. Coupling field
  3. Mechanical system
- The process of electromechanical conversion is a reversible process.

## B. TYPES OF DC MACHINES:

- DC machines are basically of two types:
  1. D.C. generator
  2. D.C. motor.
- A dc generator is rotated by a prime mover and produces a dc voltage. So it converts mechanics energy into electrical energy.
- A dc motor receives energy from a d.c. voltage source and rotates at a speed proportional to the applied voltage. So a dc motor converts the electrical energy into a mechanical energy.

## C. WINDINGS IN A DC MACHINE:

- In any dc machine, (motor or generator) there are two windings:
  1. Field winding
  2. Armature winding
- Out of these, the field winding is stationary which does not move at all and the armature winding is a movable winding.
- The armature winding is mounted on a shaft. So it can rotate freely.
- The construction of a dc generator and dc motor is the same. That means we can use the same dc machine either as a generator or as a motor.

### Connection of windings for operation as generator:

- The field winding is connected across the dc power supply.
- The field winding then produces a magnetic field in the air gap between the armature and field windings.
- The armature winding is a rotating winding which is mounted on the shaft. The shaft is mechanically coupled to another machine called prime mover as shown in Figure-3(a).

- And the connections of the armature winding are brought out. A load such as electric lamp is connected across the armature winding.

**Principle of Operation of a DC Generator:**

- The DC generator operates on the principle of dynamically induced emf in a conductor.
- According to this principle, if the flux linked with a conductor is changed, then an emf is induced into the conductor.
- In case of a DC generator, when armature winding is rotated by the prime mover, the flux linked with it changes and an emf is dynamically induced into the armature winding.
- This is the principle of operation of a generator.
- The prime mover can be a water turbine, steam engine, steam turbine or diesel engine etc.
- The direction of induced voltage in the armature winding is given by the Fleming's Right hand rule.

**GENERATION OF AC VOLTAGE:**

- Refer Figure-4(b). This single turn coil is rotated in the anticlockwise direction in the flux produced by the permanent magnet.
- Due to rotation, the conductors A and B cut the magnetic lines of flux produced by the permanent magnet.
- According to the Faraday's law of electromagnetic induction, an emf is induced into the rotating conductors.
- Due to this induced emf, current flows through the external resistance R.
- The induced emf in the single turn coil is given by,  
$$e = B l v \sin \theta$$
- Hence the shape of the induced voltage and the corresponding positions of the single turn coil are shown in Figure-5.
- Thus the single turn alternator produces a sinusoidal voltage.

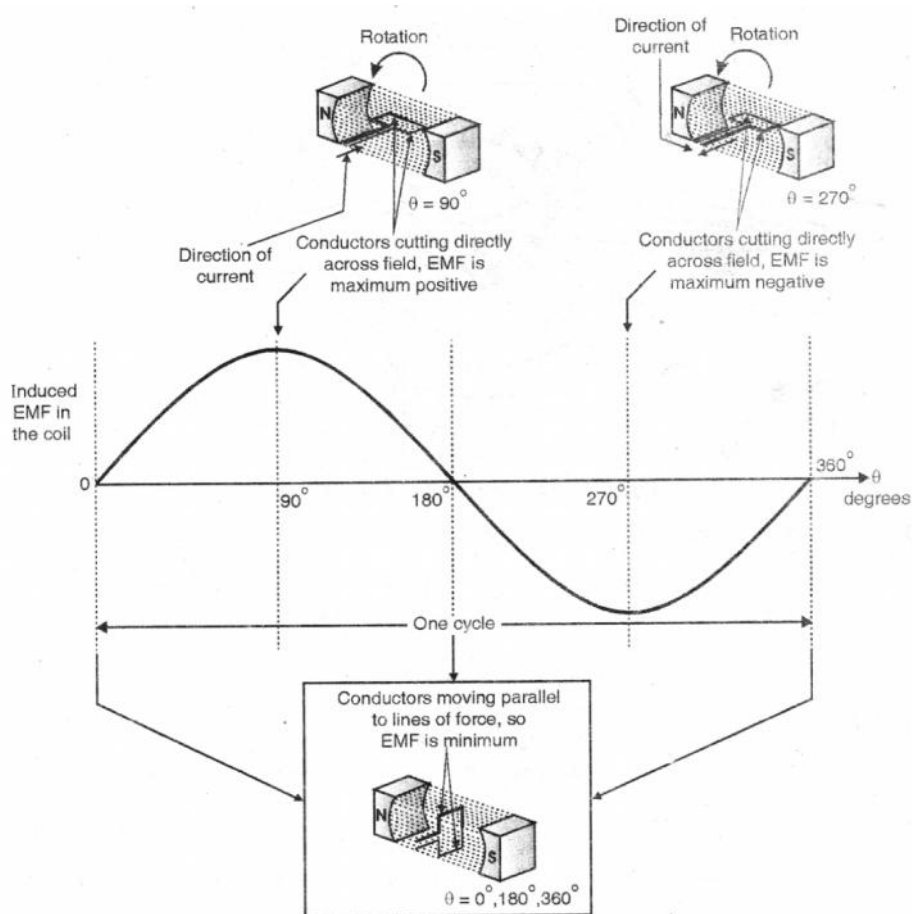

**Figure-5: Shape of induced emf and corresponding positions of single turn coil**

- In the practical dc generator also, the alternating waveform is generated internally. It is then rectified to produce the unidirectional DC voltage. This is achieved by replacing the slip-rings by a commutator.

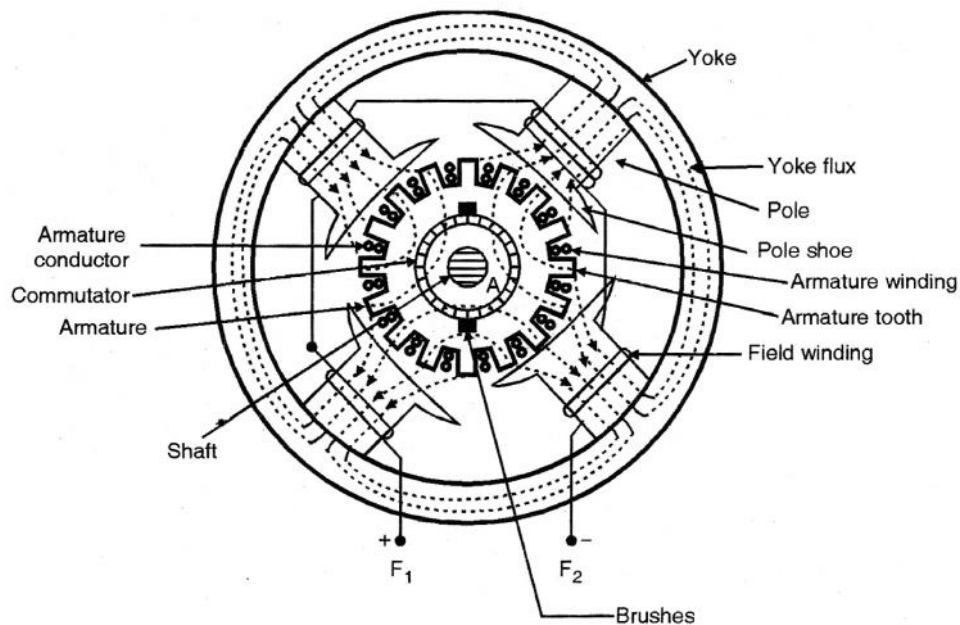
**D. CONSTRUCTION OF A DC MACHINES:****Figure-6 : Construction of a dc generator****1. Important Parts of a DC Generator:**

The cross-section of a DC generator reveals that it consists of the following important parts:

- Yoke
- Poles
- Commutator, brushes and gear
- Field winding
- Armature
- Bearings.

**2. Yoke:**

The important information about the yoke which acts as the outer cover of a DC machine are as given below:

- Yoke is also called as frame. It provides protection to the rotating and other parts of the machine from moisture, dust etc.
- Yoke is an iron body which provides the path for the flux. This is essential to complete the magnetic circuit.
- It provides the mechanical support for the poles.
- Materials used for yoke are basically the low reluctance materials such as cast iron, silicon steel, rolled steel, cast steel etc.

**3. Poles, Pole Shoe and Pole Core:**

The important points about the poles are as follows:



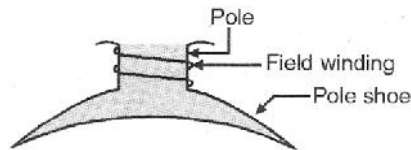

- A pole of a generator is an electromagnet. The field winding is wound over the poles.
- Poles produce the magnetic flux when the field winding is excited.
- Pole shoe is an extended part of a pole. Due to its typical shape, it enlarges the area of the pole.
- Due to this enlarged area, more flux can pass through the air gap to armature.
- A low reluctance magnetic material such as cast steel or cast iron is used for the construction of a pole or pole shoe.

#### 4. Field Winding ( $F_1 - F_2$ ):

- The coils wound around the pole cores are called field coils.
- The field coils are connected in series to form the field winding.
- Current is passed through the field winding in a specific direction, to magnetize the poles and pole shoes. The magnetic flux  $\phi$  is thus produced in the air gap between the pole shoes and armature.
- The field winding is also called as exciting winding.
- The material used for the field conductor is copper.
- Due to the current flowing through the field winding alternate N and S poles are produced which pole is produced at a particular core is decided by the right hand thumb rule for a current carrying circular conductor.

#### 5. Armature Core:

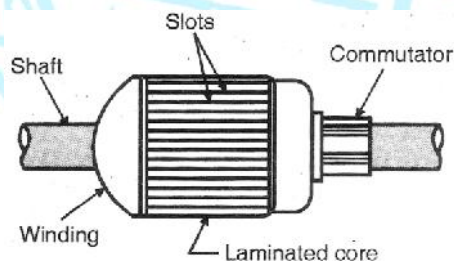

- Armature core is a cylindrical drum mounted on the shaft.
- Armature core provides a low reluctance path to the flux produced by the field winding.
- High permeability, low reluctance materials such as cast steel or cast iron are used for the armature core.
- The air holes are provided for the air circulation which helps in cooling the armature core.
- The laminated construction is used to produce the armature core to minimize the Eddy current losses.

#### 6. Armature Winding:

- The armature conductors made of copper are placed in the armature slots present on the periphery of armature core.
- Armature conductors are interconnected to form the armature winding.
- Armature winding is connected to the external circuit (load) through the commutator and brushes.



- Armature winding made up of copper.

### 7. Commutator:

The construction of a commutator is as shown in Figure-7.

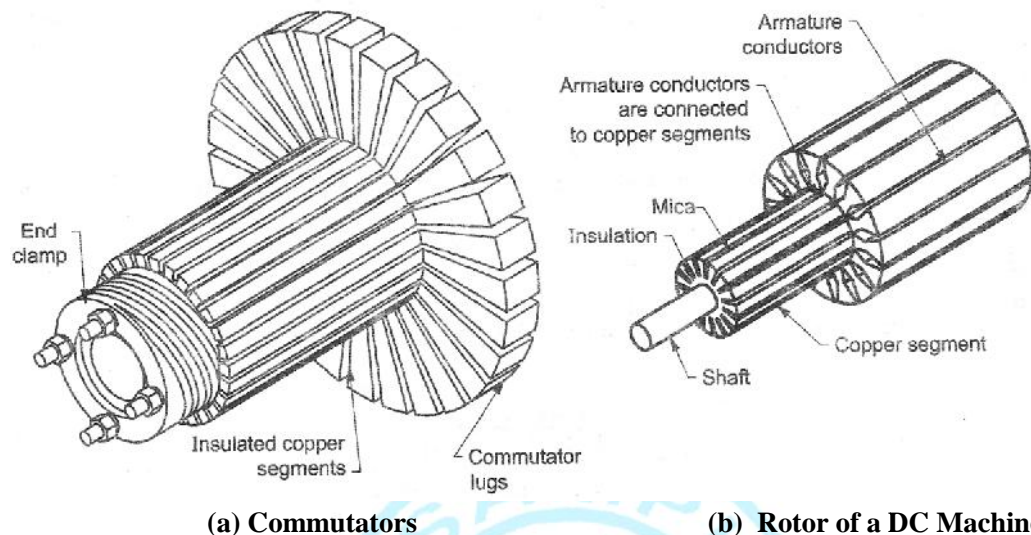

**Figure-7 : Construction of a Commutator**

- A commutator is a cylindrical drum mounted on the shaft along with the armature core.
- It is made of a large number of wedge-shaped segments of hard-drawn copper.
- The segments are insulated from each other by thin layers of mica.
- The armature winding is tapped at various points and these tappings are successively connected to various segments of the commutator.

#### Functions of a commutator:

1. It converts the alternating emf generated internally in a d.c. voltage. So it basically works like a rectifier.
2. It collects the current from the armature conductors and passes it to the external load via-brushes.
3. For dc motors, it helps to produce a unidirectional torque.

### 8. Brushes:

- Current is conducted from the armature to the external load by the carbon brushes which are held against the surface of commutator by springs.
- Brushes wear with time. Hence they should be inspected regularly and replaced occasionally.

#### Function of brushes:

To collect current from the commutator and apply it to the external load.

### E. TYPES OF ARMATURE WINDINGS:

- Armature conductors are connected together in a specific manner to construct the armature winding. The manner in which the armature conductors are connected depends on the requirements of an application.

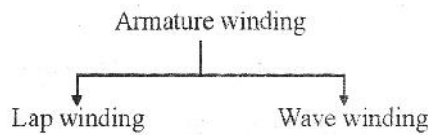

### 1. Lap Winding:

For lap winding the number of parallel paths is exactly equal to the number of poles P.

$$A = P$$

**The lap winding is useful for low voltage high current machines:**

- Due to the existence of a large number of parallel paths, the lap wound armature winding is capable of supplying larger load currents.
- But these generators are capable of generating low voltages.

In lap winding the armature conductors are divided into P groups. All the conductors in a group are connected in series and all such groups are connected in parallel.

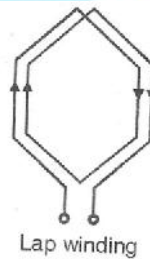

**Figure-8(a) : Simplified diagram of Lap winding**

### 2. Wave Winding:

This type of winding will create only two parallel paths irrespective of the number of poles.

∴ Number of parallel paths (A) = 2

**Wave winding is useful for high voltage low current machines:**

- Note that the number of parallel paths for wave winding will be less than that for lap winding.
- Hence this winding does not have the capability of supplying larger load currents. So the generators with wave winding are of low current ratings. But these generators are capable of producing high voltage.
- Thus in wave winding, all the conductors are connected in series to form a single closed circuit.

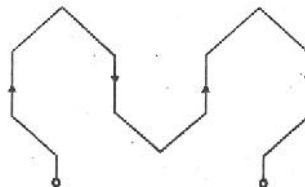

**Figure-8(b): Simplified diagram of wave winding**

**To buy Complete Course Materials**

**Contact: 9990657855, 9278800100**

Email : [eiidelhi@gmail.com](mailto:eiidelhi@gmail.com)

Website : [www.sscje.com](http://www.sscje.com)

**Classroom Coaching Program**

**Postal Coaching Program**

**Online Test Series**

